

Making Me Fundraising Pack

We are delighted to be joining your school to help spread the **Making Me** message. At **Making Me** we know that life can come with many hurdles, and our vision is to give children the knowledge and power to thrive – skills that are needed now more than ever. So that we can continue to provide the support many children desperately need, it is vital to raise funds to support the running of the **Making Me** charity. **Thank you for helping to make that happen.**

What you can do:

Whether your school chooses to host a cake sale, a sponsored resilience run, or a sunflower growing competition, we want to help ensure your event is both a success and, most importantly, jolly good fun.

From event poster designs to a printable scavenger hunt and make your own bunting, we have put together a kit to get you started – although you're welcome to come up with your own brainwaves too!

Here are some ideas and top tips to help kick you off. Delve in and find:

- An [event poster](#) to personalise
- A [cake sale poster](#) and recipe idea on how to make a [©KIPSY caterpillar cake](#)
- [Sponsorship form templates](#) for resilience runs and walks
- [Printable Q&A fun family quiz](#)
- [Scavenger hunt](#) for the little ones
- [Nature challenge](#), [insect hotel](#) and [©KIPSY cress caterpillar](#) instructions
- [Pom pom ©KIPSY](#) instructions
- Kids' [colouring in pages](#)
- Make your own [©KIPSY bunting template](#)
- [Thank you note templates](#) so you can publicise how much you have raised.



Thank you so much for helping to give something back to **Making Me**. Whilst our main focus is, of course, the children and our aim is to guide them through their journey into adolescence, we could not do it without your fundraising support.

If possible, please share this fundraising pack with your PTA and perhaps even ask for us to be their fundraising cause of the year.

Should you have any questions, please contact us with your questions by emailing us at contactus@makingme.org.uk and please ensure that your events comply with the latest Government COVID-19 advice.

Here's wishing you lots of success with your event, and hopefully a lot of fun along the way.

Warmest regards, The Making Me Team

©MakingMe2021. All rights reserved. Schools have the right to reproduce the copyrighted material in this fundraising pack to carry out fundraising activities as agreed with Making Me .

You're invited to join our

Making Me Fundraiser Day

We're hosting a fundraiser day in support of the Making Me charity that strives to help our children thrive.

When:

Where:

From:

For more information, visit [www.makingme.org.uk /](http://www.makingme.org.uk/)



Charity No. 1176751
Registered in England and
Wales

**Knowledge
Is
Power
Strengthening
You**



©MakingMe2021

We're Supporting the Making Me Charity
that strives to help our children thrive!



**Knowledge
Is
Power
Strengthening
You**



Charity No. 1176751
Registered in England and Wales

Our Making Me Fundraiser Day

What:

When:

Where:

For more information, visit www.makingme.org.uk /

We're Supporting the Making Me Charity
that strives to help our children thrive.



**Knowledge
Is
Power
Strengthening
You**

Our Making Me Fundraiser Day

What:

When:

Where:

For more information, visit www.makingme.org.uk /

Making Me Cake Sale

Get your yummy cakes, biscuits and sweet treats here in aid of the Making Me charity that strives to help our children thrive.

MENU:

PRICES:

Allergens:

TAKE AWAY AVAILABLE!



Charity No. 1176751
Registered in England and Wales

**Knowledge
Is
Power
Strengthening
You**

©KIPSY Caterpillar Cake Ideas

50_p

Why not make some ©KIPSY cakes to share with your friends or even sell for donations to the Making Me charity?

INGREDIENTS TO MAKE 2 KIPSYs

- 115 + 100g butter softened
- 115g caster sugar
- 125g self-raising flour
- 1tsp baking powder
- 2 large eggs
- 1 + 1 tbsp semi-skimmed milk
- 200g icing sugar
- 1/4tsp vanilla extract
- Coloured icing or writing icing
- Sweet treats like M&Ms, fizzy laces, dolly mixture, cherries or raisins
- 12 paper cases and a bun tray
- Display boards or plates

METHOD

- Preheat the oven to 180C/160C Fan/Gas 4. Line bun tray.
- Cream together 115g of butter with the caster sugar, then slowly beat in the eggs, flour, baking powder, and 1tbsp of the milk until creamy.
- Divide the mixture evenly between the paper cases.
- Bake for 18-20 minutes then transfer to a wire rack to cool.
- Mix the remaining butter with the icing sugar until smooth, then add the rest of the milk and the vanilla extract.
- Beat 'til creamy then spread your mix on top of the cakes.
- Take 2 of cakes to make two faces. You can use writing icing to draw on glasses and smiley mouth. We used a dolly mixture nose. For the antennae, try threading fizzy laces on cocktail sticks to help them stand up* and top each one off with M&Ms, glace cherries or a couple of raisins.
- Spell ©KIPSY on the remaining cakes. We used coloured icing, but you could make letters from mini Smarties or M&Ms. We also used hundreds & thousands for extra zing!
- Place the cakes in order on your display plate. As a finishing touch, add fizzy laces with M&Ms, cherries or raisins on the end for the legs. You can use leftover icing as "glue."



Tip: See if you can get a friend, local business or supermarket to sponsor the cost of your sweets all for a very good cause!

* Remember to remove cocktail sticks before giving to small children



© KIPSY's Fun Family Quiz



£2

How about some fun for all the family? All the answers to this quiz relate to animals, birds or insects. With Music, Literature and Cryptic Conundrums, there should be something for everyone. Find a biro and see how many answers you can find.

Round One – Cryptic

1. Airborne Dairy Product
2. Almost a gymnast's outfit but always with the same spots
3. A letter of the alphabet
4. Someone who makes a piano sound better
5. Something to keep part of your face cool
6. A kind of howl?
7. No clothes on!
8. Expensive

Round Two – Literature

1. What are the animals in Watership Down?
2. Who is Crookshanks?
3. What animal is the rebellion-leading Snowball?
4. What animal "drank all of Daddy's beer!"
5. What sort of animal is Mrs Tiggywinkle?
6. Name the 4 animals in Wind in the Willows
7. What animal is Black Beauty?
8. If you waded through long wavy grass and thick oozy mud, what animal are you hunting?

Round Three – Music

1. Tones and I song: Dance _____
2. Whose eye was like the thrill of the fight?
3. Who is asleep in the mighty jungle?
4. Which animals sing Hakuna Matata?
5. A chorus of which animals feature in a Paul McCartney song?
6. She was finished off by eating a horse, but what did the old woman start off with?
7. Which musical features the song "Memories?"
8. What animal did Alice the Camel become?

Good Luck!



Charity No. 1176751
Registered in England and
Wales

**Knowledge
Is
Power
Strengthening
You**



Fun Family Quiz Answers



How did you get on? Easy or way too tricky?

Round One – Cryptic

1. Butterfly
2. Leopard
3. Bee
4. A tuna
5. Chinchilla
6. A whale
7. Bear
8. Deer

Round Two – Literature

1. Rabbits
2. Hermione's cat in the Harry Potter books
3. A pig in George Orwell's Animal Farm
4. A tiger (who came to tea)
5. A hedgehog
6. Mole, Rat, Toad, and Badger
7. A horse
8. A bear

Round Three – Music

1. Monkey
2. The tiger's
3. The lion
4. A meercat and a warthog
5. Frogs
6. A fly
7. Cats
8. A horse



Charity No. 1176751
Registered in England and
Wales

©KIPSY's Fun Family Quiz Answer Sheet – Fundraiser Quiz for **Making Me** Supporting the Children in Our School.
Identify as many answers as you can **TO WIN** :

Round One – Cryptic

1. _____
2. _____
3. _____
4. _____
5. _____
6. _____
7. _____
8. _____

Round Two – Literature

1. _____
2. _____
3. _____
4. _____
5. _____
6. _____
7. _____
8. _____

Round Three – Music

1. _____
2. _____
3. _____
4. _____
5. _____
6. _____
7. _____
8. _____

Name and Contact Details :

Closing Date: __ / __ / __

* In the event of a tie, the winner will be drawn from a hat



© KIPSY's Nature Challenge



There's nothing like nature to put a smile on your face. Here are some ideas for encouraging wildlife into your home or garden.

1) Plants

Plant wildflower seeds in your garden or maybe in a window box made from an old margarine or ice cream tub.

Did you know you can grow edible plants like tomatoes, mint or even nasturtium flowers?

You could also do a sunflower growing competition with friends and family?



Some people say talking to plants helps them to grow. You can also sprinkle tea leaves from used tea bags around your plants to provide helpful nutrients. And don't forget to water them.

2) Insects

Bumblebees are an important part of our gardens. Don't be scared, they only sting if you sit on them or pick them up.

The wild flowers you planted will help bees & other insects, and you can also leave water in shallow saucers with stones in to help them drink.

Why not make a bug hotel to welcome insects? Cut out the side of an old milk carton and stack it with the cardboard toilet roll inner tubes. Stuff these with moss, grass, pine cones and paper to make it cosy. You could decorate the top with daisy chain bunting!



3) Birds



Making bird feeders is a great way to encourage feathered friends into the garden.

If you have an old apple with brown spots, cut it in half, scoop out the core and seeds, then stuff the hole with a bird seed and peanut butter. You can then hang it from a tree.

Or try taking the peel of half an eaten orange and filling it with seeds or nuts. Poke four holes in the rind and thread twine through the holes to create a hanging basket.

Put them up high so cats can't get to them. And put out fresh water in a saucer.



Charity No. 1176751
Registered in England and
Wales

**Knowledge
Is
Power
Strengthening
You**



© KIPSY's Insect Hotel



50p

Why not make your own Insect Hotel to encourage caterpillars and their friends into your garden?

WHAT YOU NEED

- Empty milk carton
- Sharp knife
- Scissors
- Mix of pebbles, sticks, flowers, pine cones, leaves and weeds
- Toilet roll tubes
- Glue (optional)
- Hole punch
- Insect Hotel sign

Cut the handle corner off your carton to create the base for your insect hotel. Use the knife to pierce a hole, then use the scissors to cut the hotel outline.



To make a mini maze for your insects, punch holes into the toilet roll tubes and poke sticks through. The insects will enjoy exploring!

Build up the interior of your hotel in layers starting with heavier things like pebbles first. Pop in the toilet rolls complete with mini climbing frames. Add in flowers and greenery for colour. You can glue the pieces together to make it sturdier if you like.



Add your Insect Hotel sign, carry it carefully to the garden and you're open for business!

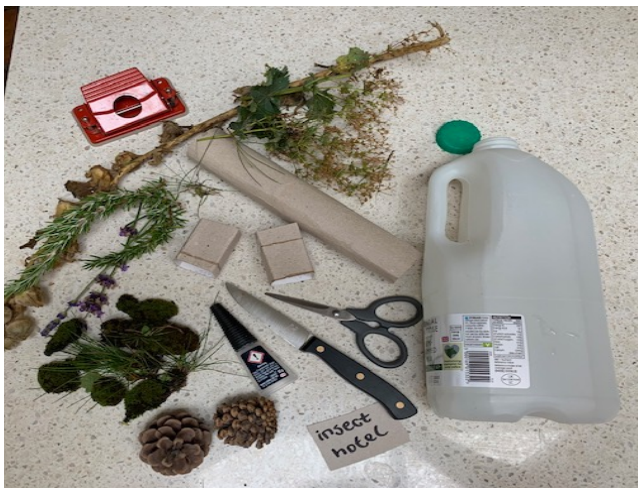

TIP:
Place your Insect Hotel in a shady spot but that gets a bit of sunshine for best results.

Knowledge Is Power Strengthening You



Charity No. 1176751
Registered in England and Wales



©KIPSY Cress Caterpillar



50_p

Why not make a ©KIPSY cress caterpillar? You can make egg & cress sandwiches to share or even sell for **Making Me?**

WHAT YOU NEED

- 3 toilet roll inner tubes
- Scissors, pencil
- Ruler, glue
- Cotton buds
- Cotton wool
- Cress seeds
- KIPSY's face and name template



Flatten a toilet roll and crease the edges. Cut it in half. Then, fold each piece in half again so that you make two squares.

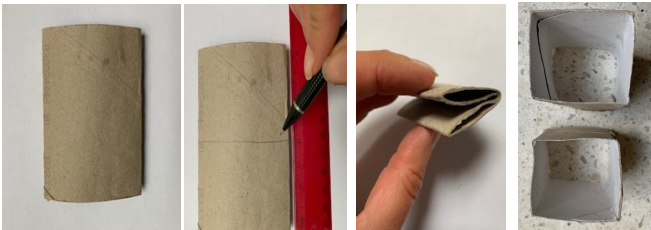

Measure half way up each piece, then make a cut at each corner from the bottom to the line. Fold the flaps inwards and glue to make a base. Repeat for the other half, and the other two rolls.

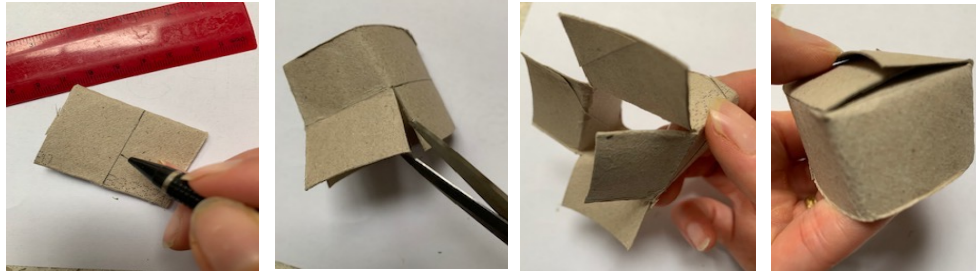

Use felt tips or paints to colour the six boxes.



Now draw and colour ©KIPSY's face and name, or print the template overleaf. Cut out and stick on.

Colour the cotton buds black, cut off the ends and

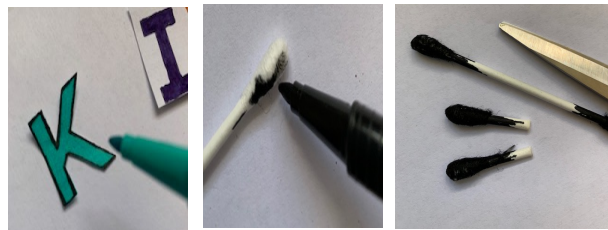

push them into the boxes to make legs and antennae, or stick with glue.

Fill each box with cotton wool and sprinkle cress seeds on top. Keep them watered until they grow.



TIPS:
To make a simpler body, cut an egg box base in half.
If the legs are too fiddly, just draw them on in pen.

Knowledge Is Power Strengthening You

making me

Charity No. 1176751
Registered in England and Wales

You can cut out this template to help with ©KIPSY's face and letters

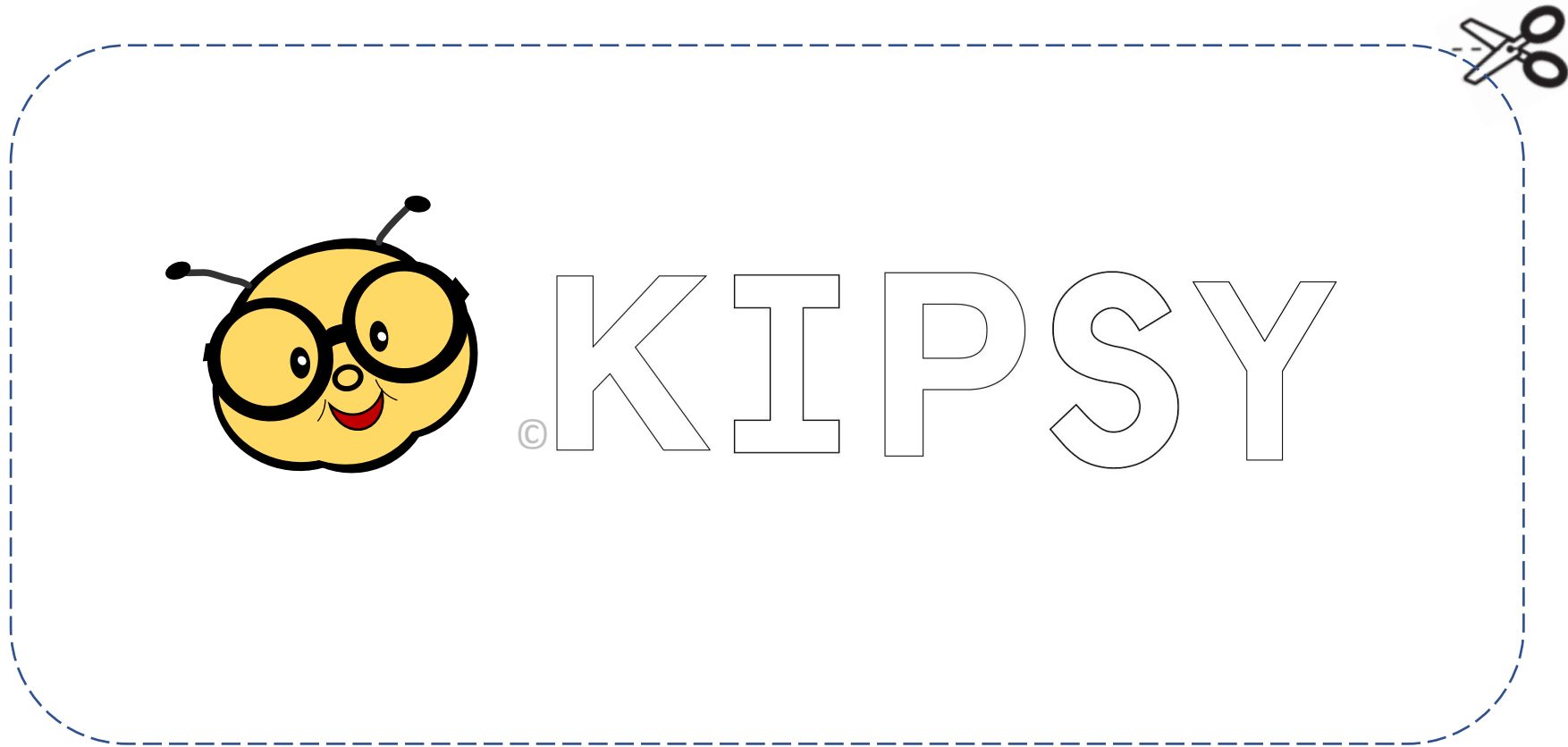



©KIPSY's Scavenger Hunt



50_p

How many things can you find from the list? You'll be surprised to find what's right under your nose once you start looking!

Something beginning with K

Just like our friend ©KIPSY, see if you can find something that starts with a kicking K.

Draw or write what you find here:

Crazy Daisies

©KIPSY's letter S sits amongst some pretty daisies. Can you find any daisies? Try making a daisy chain.



I Spy With My Little Eye

©KIPSY wears some cool glasses. How many people can you count wearing glasses today?

Colours

How many bright colours can you count on ©KIPSY's wiggly body? See if you can find something bright green.

Draw or write what you find here:

Incy Wincy Spider

How many of ©KIPSY's insect friends can you spot? Can you think of any stories or rhymes about them?

Round and Round

How many circles can you count on ©KIPSY?

Look around you and see what else you notice that's shaped in a circle.

Draw or write what you find here:

Counting Game

How many minutes would it take to put on your shoes if you had as many legs as ©KIPSY?

Name Game

©KIPSY's name is made up of 5 letters. How many letters are there in your name?

A Little Joke to Finish

Q: What scares a Caterpillar?



A: A Dogerpillar?



Charity No. 1176751
Registered in England and Wales

**Knowledge
Is
Power
Strengthening
You**



Pom Pom ©KIPSY



Why not make a ©KIPSY out of wool scraps? You can keep your very own ©KIPSY on display at school or at home!

WHAT YOU NEED

- Cardboard, yoghurt pot, coin
- Pencil, glue, scissors
- Colourful wool
- Fabric scraps
- Glue
- Pipe cleaners
- Googly eyes



Draw round the yoghurt pot onto the cardboard and the coin in the middle. Mark a wedge, then cut out the C. Make a 2nd C the same.

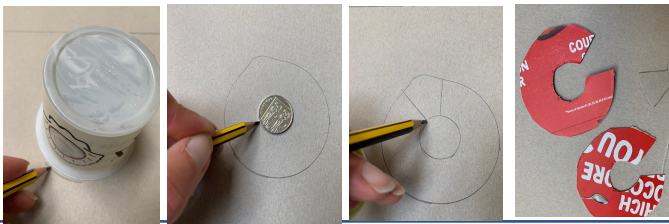

Line the 2 cardboard Cs side by side, then lie the end of your first choice of wool against the card. Wind the wool through the wedge gap, and round and round the circle until you've covered it thickly.



Hold onto the middle with your thumb and cut the wool by putting the scissors between the two Cs. Take an extra length of wool and wind it around the middle, between the cardboard Cs. Tie a tight knot. Now take off the cardboard – ta da, a pom pom! Make five more, enough for KIPSY's body and head.



Now thread small lengths of pipe cleaner through the knotted wool to make legs and antennae. Draw & cut out the letters on your fabric, and a big smile too. Put some eyes in pipe cleaner glasses. Glue it all together. Yay a cuddly ©KIPSY!



TIPS:
An old cereal box is great for the cardboard Cs.
Use any wool colours or funky fabric to make your ©KIPSY personal to you.

Knowledge Is Power Strengthening You



Charity No. 1176751
Registered in England and Wales

Name	Amount
Total	

Thank You

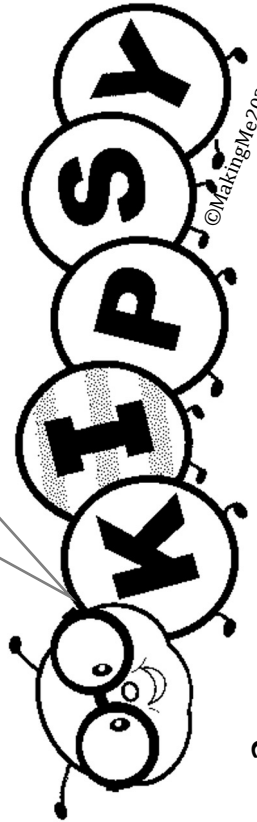

©MakingMe2021

Knowledge
Is
Power
Strengthening
You

making
me

Charity No. 1176751
Registered in England and Wales

Making Me Resilience Run

Pupil's Name _____

Class / Teacher Name: _____

Name	Amount
Total	



Thank You

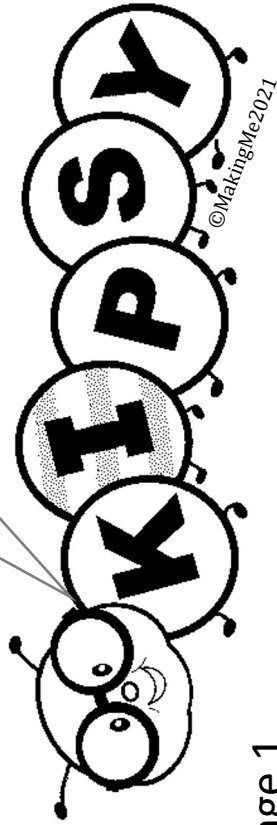

©MakingMe2021

**Knowledge
Is
Power
Strengthening
You**



Charity No. 1176751
Registered in England and Wales

Name	Amount
Total	

Thank You

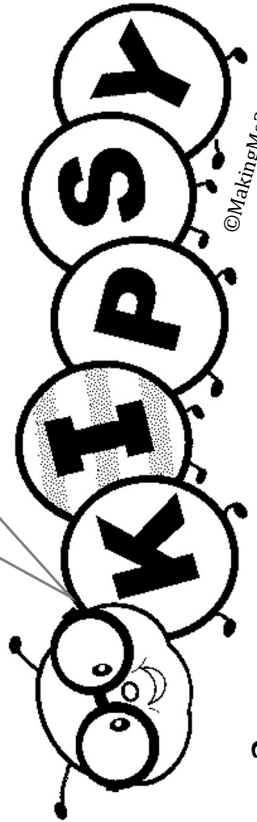

© MakingMe2021

**Knowledge
Is
Power
Strengthening
You**

 making
me

Charity No. 1176751
Registered in England and Wales

Make Your Own KIPSY Bunting

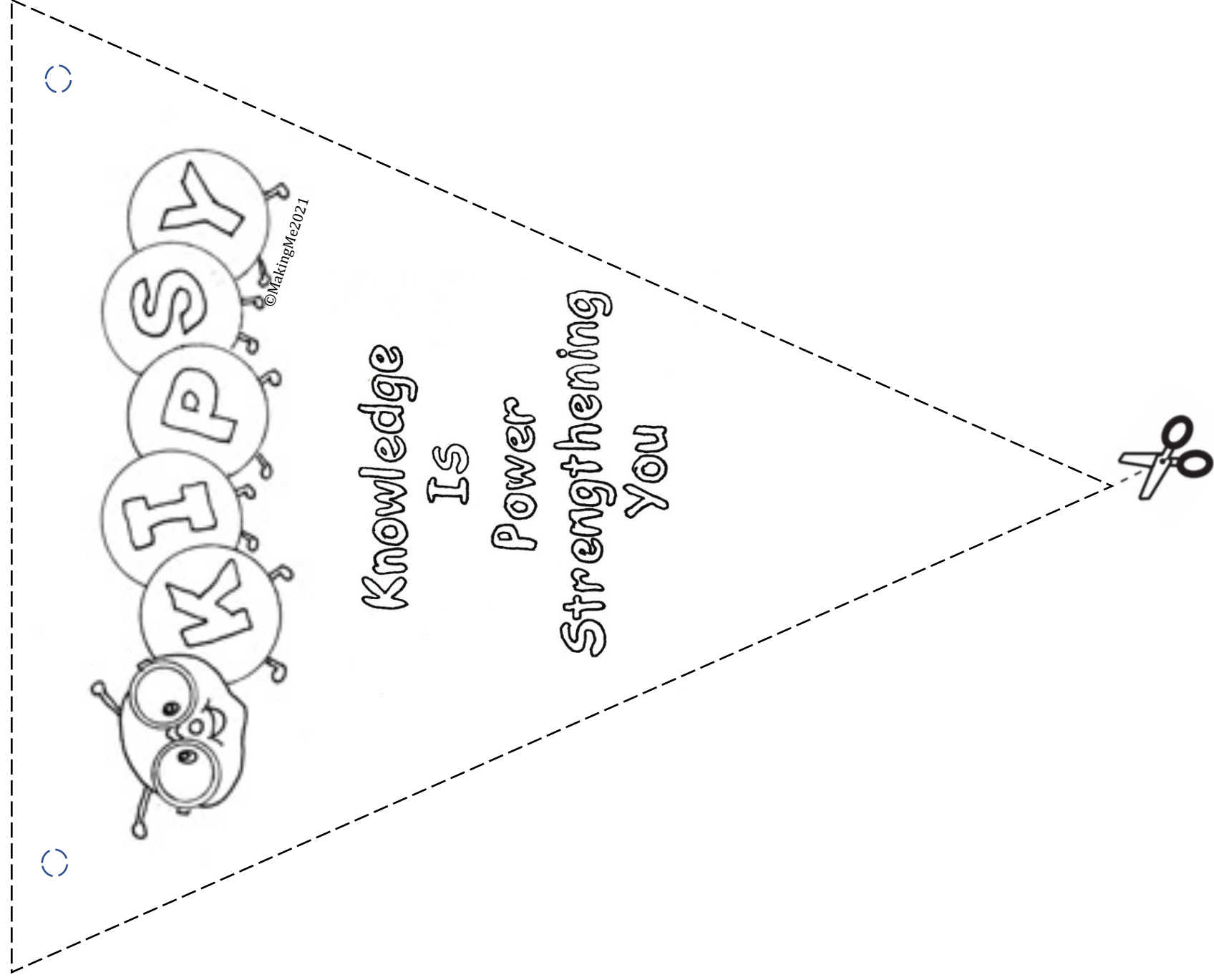

Print the template onto jolly paper, cut out the triangles and punch holes in the corners where the circles are.

The more you do the merrier!
Thread together with string and hang them up to brighten everyone's day!

**Knowledge
Is
Power
Strengthening
You**



Charity No. 1176751
Registered in England and Wales

Colour your own cake poster

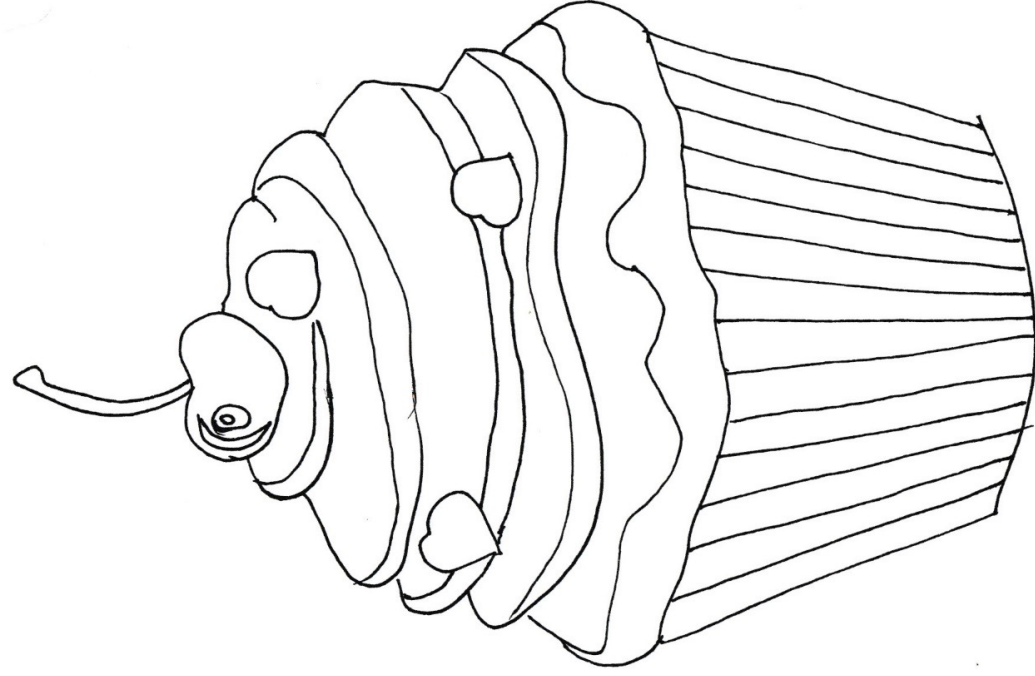

Yummy

CAKE



Colour your own Resilience Run poster

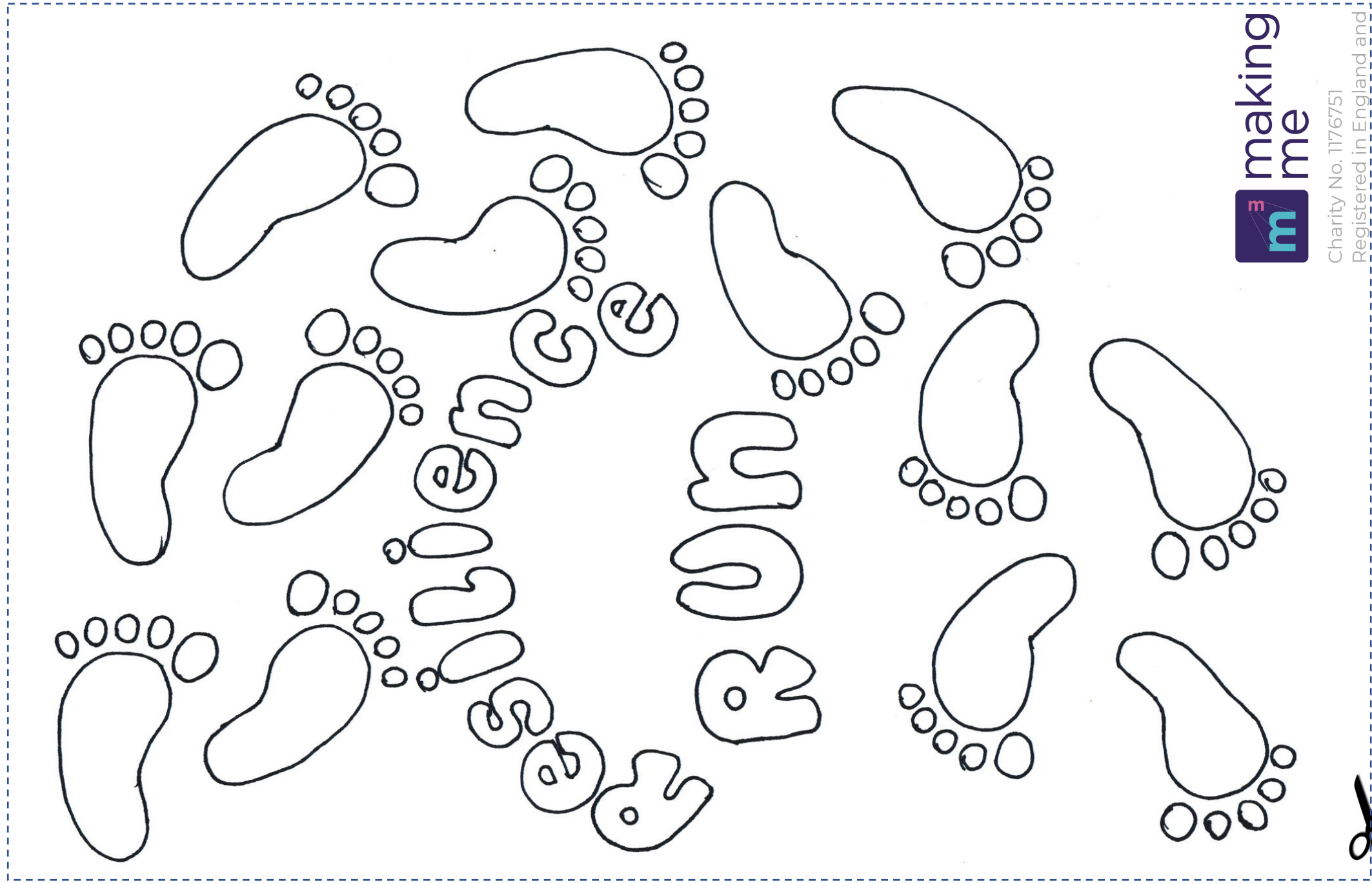

Colour your own Feelings Tree

How calm I

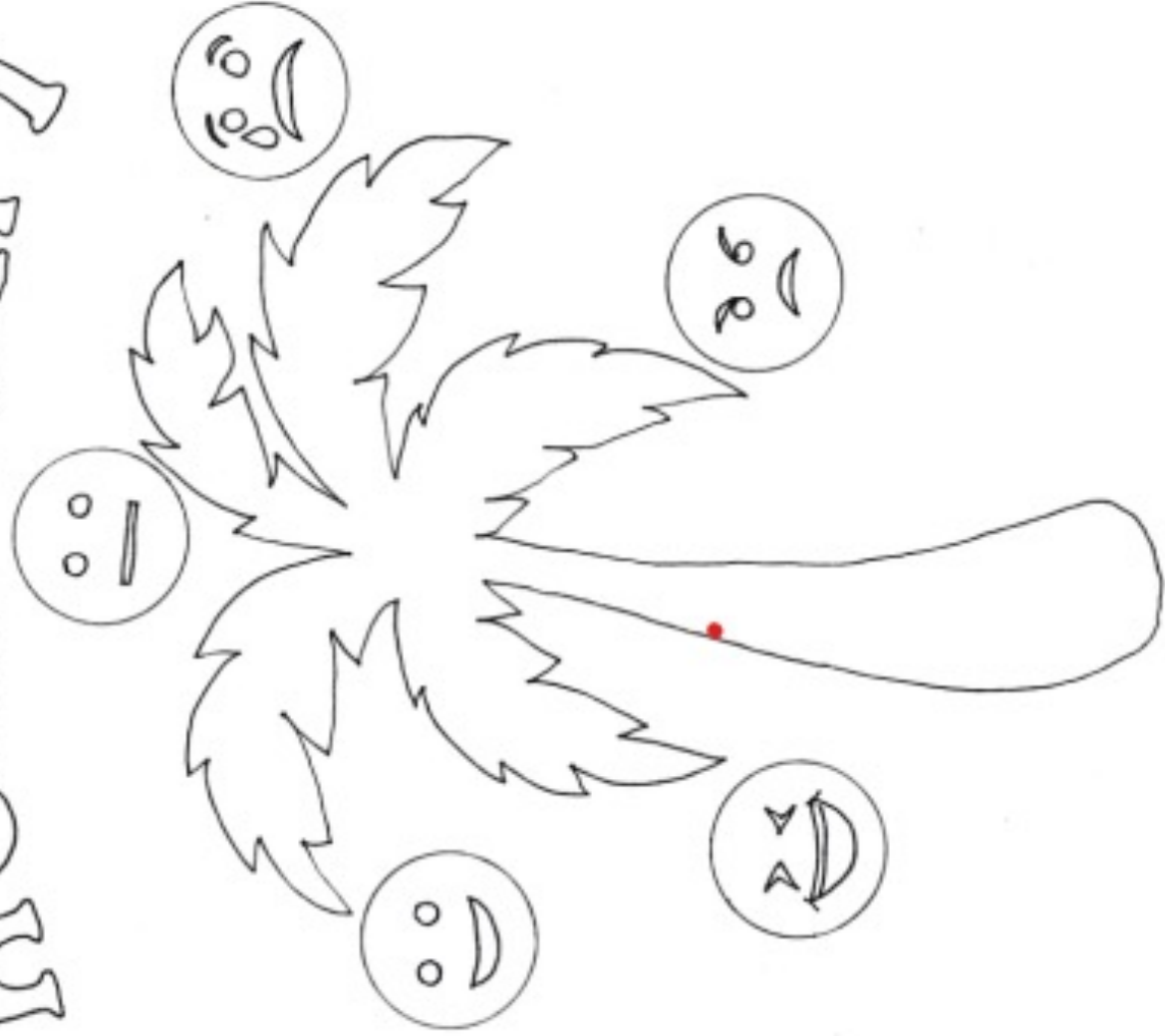

Feeling?



THANK YOU!

Our fundraising event raised an amazing ... in aid of the Making Me Charity that strives to help our children.

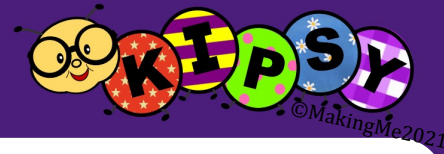

**Knowledge
Is
Power
Strengthening
You**



Charity No. 1176751
Registered in England and Wales

EASY FUNDRAISING

If you've not heard of #easyfundraising before, here's some **great** news. Just by internet shopping, you can help to raise money for Making Me.

When you sign up as a supporter, 4,300 shops and sites will donate for free, every time you shop online.

This includes all the big names like eBay, John Lewis & Partners, Argos, ASOS, Expedia, M&S, Just Eat and more! Frankly, it would be mad not to.

Please encourage parents and staff to sign up here:

<https://www.easyfundraising.org.uk/causes/makingme>

Thank you!



**Knowledge
Is
Power
Strengthening
You**



Charity No. 1176751
Registered in England and Wales

BUSINESS SPONSORSHIP

Many organisations elect a **charity for the year**.

Perhaps you could approach some well-respected and well-established local organisations to your school, or a business associated with one of your school's parents, and ask if they would consider adopting Making Me as their annual charity.

They could help with your fundraising efforts, which will of course help boost the total money you might raise. They would help promote your events and might lend manpower. It makes them look good and raises their profile.

It's a **Win : Win** situation!



**Knowledge
Is
Power
Strengthening
You**



Charity No. 1176751
Registered in England and Wales